

# **Gasoline Engine Owner's Manual**

---

**1P65FE**

**1P65FE-2**

**1P65FE-3**

**1P65FE-4**

**1P65FE-5**

**1P70F-3**

**1P75F**

**V200**

**V225-7**

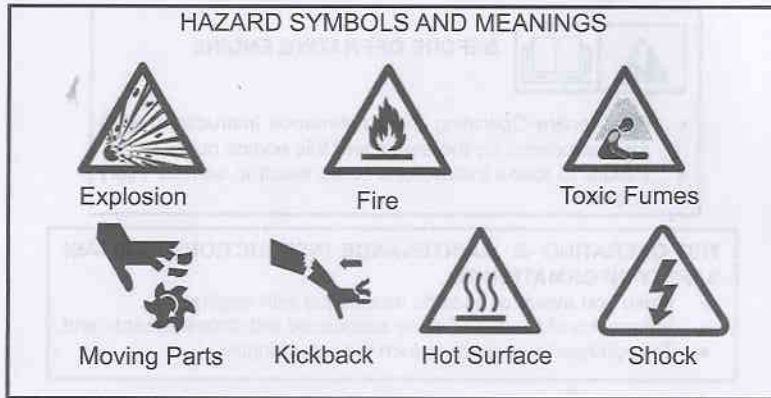

**CONTENTS**

**CONTENTS**

<b>1. ENGINE SAFETY</b> .....	2
<b>2. COMPONENTS</b> .....	5
2.1 COMPONENTS OF ENGINE.....	5
<b>3. CONTROLS</b> .....	6
3.1 ENGINE OIL .....	6
3.2 FUEL .....	7
3.3 STARTING ENGINE.....	7
3.4 STOPPING ENGINE .....	8
<b>4. MAINTENANCE</b> .....	9
4.1 THE IMPORTANCE OF MAINTENANCE .....	9
4.2 MAINTENANCE SAFETY .....	9
4.3 MAINTENANCE SCHEDULE .....	10
4.4 CHANGE ENGINE OIL .....	10
4.5 REFUELING .....	11
4.6 AIR CLEANER .....	11
4.7 SPARK PLUG SERVICE.....	12
<b>5. STORAGE/ TRANSPORTING</b> .....	13
5.1 STORING YOUR ENGINE .....	13
5.2 STORAGE PRECAUTIONS .....	14
5.3 REMOVAL FROM STORAGE .....	15
5.4 TRANSPORTING .....	15
<b>6. TROUBLESHOOTING</b> .....	16
<b>7. TECHNICAL &amp; CONSUMER INFORMATION</b> .....	17
<b>8. SPECIFICATIONS</b> .....	18
8.1 ENGINE SPECIFICATIONS .....	18

## 1. ENGINE SAFETY





## IMPORTANT SAFETY INFORMATION

Most accidents with engines can be prevented if you follow all instructions in this manual and on the engine. Some of the most common hazards are discussed below, along with the best way to protect yourself and others.

## Owner Responsibilities

- The engines are designed to give safe and dependable service if operated according to instructions. Read and understand this owner's manual before operating the engine. Failure to do so could result in personal injury or equipment damage.
- Know how to stop the engine quickly, and understand the operation of all controls. Never permit anyone to operate the engine without proper instructions.
- Do not allow children to operate the engine. Keep children and pets away from the area of operation.

 <p>Fire Explosion</p>	<p><b>WARNING</b></p> <p>Gasoline and its vapors are extremely flammable and explosive. Fire or explosion can cause severe burns or death.</p>
<p><b>WHEN ADDING FUEL</b></p>	
<ul style="list-style-type: none"> <li>• Turn engine OFF and let engine cool at least 2 minutes before removing gas cap.</li> <li>• Fill fuel tank outdoors or in well-ventilated area.</li> <li>• Do not overfill fuel tank. Fill tank to approximately 1-1/2 inches below top of neck to allow for fuel expansion.</li> <li>• Keep gasoline away from sparks, open flames, pilot lights, heat, and other ignition sources.</li> <li>• Check fuel lines, tank, cap, and fittings frequently for cracks or leaks. Replace if necessary.</li> </ul>	
<p><b>WHEN STARTING ENGINE</b></p>	
<ul style="list-style-type: none"> <li>• Make sure spark plug, muffler, fuel cap and air cleaner are in place.</li> <li>• Do not crank engine with spark plug removed.</li> <li>• If fuel spills, wait until it evaporates before starting engine.</li> <li>• If engine floods, set choke to OPEN/RUN position, place throttle in FAST and crank until engine starts.</li> </ul>	
<p><b>WHEN OPERATING EQUIPMENT</b></p>	
<ul style="list-style-type: none"> <li>• Do not tip engine or equipment at angle which causes gasoline to spill.</li> <li>• Do not choke carburetor to stop engine.</li> </ul>	
<p><b>WHEN TRANSPORTING EQUIPMENT</b></p>	
<ul style="list-style-type: none"> <li>• Transport with fuel tank EMPTY or with fuel shut-off valve OFF</li> </ul>	
<p><b>WHEN STORING GASOLINE OR EQUIPMENT WITH FUEL IN TANK</b></p>	
<ul style="list-style-type: none"> <li>• Store away from furnaces, stoves, water heaters or other appliances that have pilot light or other ignition source because they can ignite gasoline vapors.</li> </ul>	

 <p>Fire Explosion</p>	<p><b>WARNING</b></p> <p>Starting engine creates sparking. Sparking can ignite nearby flammable gases. Explosion and fire could result.</p>
<ul style="list-style-type: none"> <li>• If there is natural or gas leakage in area, do not start engine.</li> <li>• Do not use pressurized starting fluids because vapors are flammable.</li> </ul>	
 <p>Kickback</p>	<p><b>WARNING</b></p> <p>Rapid retraction of starter cord (kickback) will pull hand and arm toward engine faster than you can let go. Broken bones, fractures, bruises or sprains could result.</p>
<ul style="list-style-type: none"> <li>• When starting engine, pull cord slowly until resistance is felt, then pull rapidly.</li> <li>• Remove all external equipment/engine loads before starting engine.</li> <li>• Direct coupled equipment components such as, but not limited to, blades, impellers, pulleys, sprockets, etc., must be securely attached.</li> </ul>	
 <p>Toxic Fumes</p>	<p><b>WARNING</b></p> <p>Engines give off carbon monoxide, an odorless, colorless, poison gas. Broken bones, fractures, bruises or sprains could result.</p>
<ul style="list-style-type: none"> <li>• Start and run engine outdoors.</li> <li>• Do not start or run engine enclosed area, even if doors or windows are open.</li> </ul>	
 <p>Moving Parts</p>	<p><b>WARNING</b></p> <p>Rotating parts can contact or entangle hands, feet, hair, clothing, or accessories. Traumatic amputation or severe laceration can result.</p>
<ul style="list-style-type: none"> <li>• Operate equipment with guards in place.</li> <li>• Keep hands and feet away from rotating parts.</li> <li>• Tie up long hair and remove jewelry.</li> <li>• Do not wear loose-fitting clothing, dangling drawstrings or items that could become caught.</li> </ul>	
 <p>Fire Hot Surface</p>	<p><b>WARNING</b></p> <p>Running engines produce heat. Engine parts, especially muffler, become extremely hot. Severe thermal burns can occur on contact. Combustible debris, such as leaves, grass, brush, etc. can catch fire.</p>
<ul style="list-style-type: none"> <li>• Allow muffler, engine cylinder and fins to cool before touching.</li> <li>• Remove accumulated combustibles from muffler area and cylinder area.</li> </ul>	



**WARNING**

Unintentional sparking can result in fire or electric shock.  
 Unintentional start-up can result in entanglement, traumatic amputation, or laceration.

**BEFORE PERFORMING ADJUSTMENTS OR REPAIRS**

- Disconnect spark plug wire and keep it away from spark plug.

**WHEN TESTING FOR SPARK**

- Use approved spark plug tester.
- Do not check for spark with spark plug removed.

**2. COMPONENTS**

**2.1 COMPONENTS OF ENGINE**

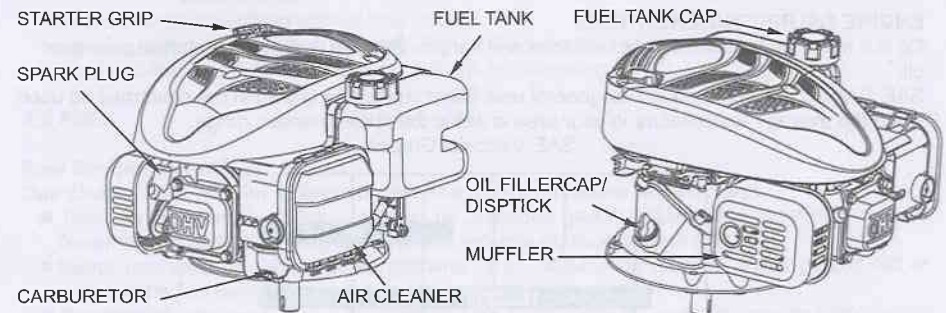

**1P65FE 1P65FE-3**

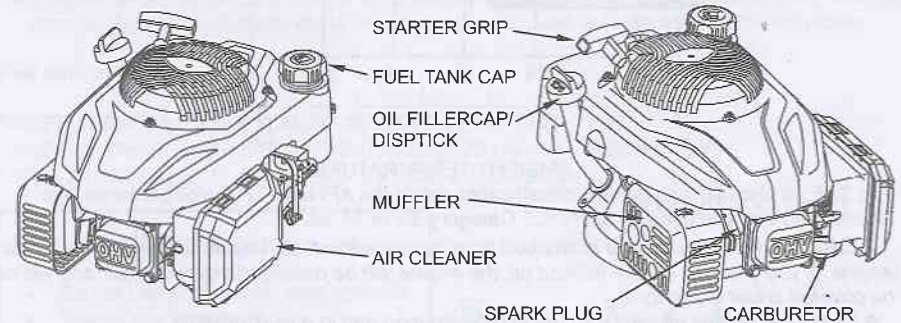

**1P65FE-2 1P65FE-4 1P65FE-5 V200**

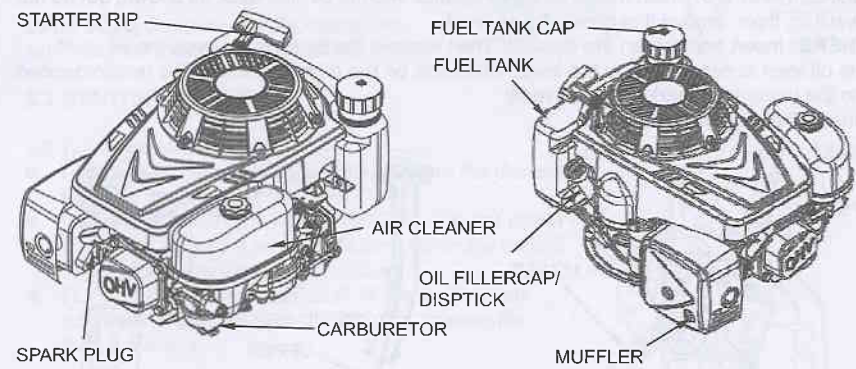

**1P70F-3 1P75F V225-7**

3. CONTROLS

3.1 ENGINE OIL

ENGINE OIL RECOMMENDATIONS

Oil is a major factor affecting performance and service life. Use 4-stroke automotive detergent oil. SAE 10W-30 is recommended for general use. Other viscosities shown in the chart may be used when the average temperature in your area is within the recommended range.

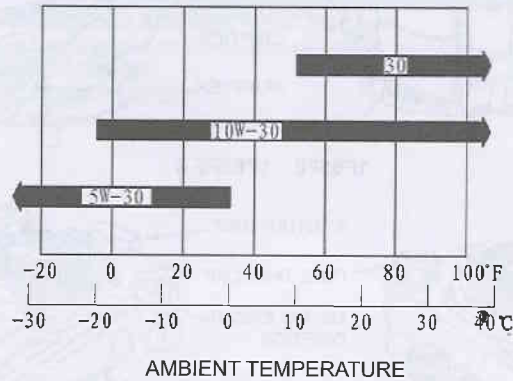

The SAE oil viscosity and service classification are in the API label on the oil container. We recommend that you use API SERVICE Category SE or SF oil.

**CAUTION:** This engine is shipped from factory without oil. Check oil level before starting engine. If you start the engine without oil, the engine will be damaged beyond repair and will not be covered under warranty.

- Check the engine oil level with the engine stopped and in a level position.
- Remove the oil filler cap/dipstick and wipe it clean.
- **1P65FE, 1P65FE-3:** Insert the oil filler cap/dipstick into the oil neck as shown, but do not screw it in, then remove it to check the oil level.
- **OTHERS:** Insert and tighten the dipstick. Then remove the dipstick to check the oil level
- If the oil level is near or below the lower limit mark on the dipstick, fill with the recommended oil to the upper limit mark. Do not overfill.
- Reinstall the oil filler cap/dipstick.

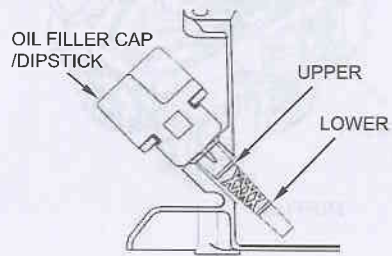

1P65FE 1P65FE-3

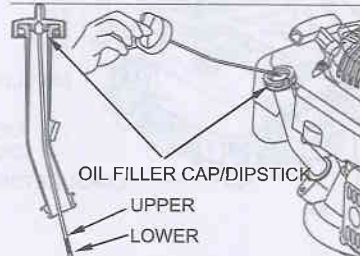

1P65FE-2 1P65FE-4 1P65FE-5  
1P70F-3 1P75F V200 V225-7

Engine oil capacities:

1P65FE, 1P65FE -2, 1P65FE -3, 1P65FE -4, 1P65FE -5, 1P70F-3, 1P75F, V200, V225-7 : 0.5L ( 0.132 US Gal , 0.110 Imp Gal )

**CAUTION:**

Do not overfill. Overfilling with oil may cause:  
Smoking, Hard starting, Spark plug fouling, or Oil saturation of air filter.  
Used oil should be sent to special recycle bin for disposing.

3.2 FUEL

Fuel Recommendations

Use clean, fresh, regular unleaded gasoline with a minimum of 85 octane.

- These engines are certified to operate on unleaded gasoline. Unleaded gasoline produces fewer engine and spark plug deposits and extends exhaust system life.
- Never use stale or contaminated gasoline or an oil/gasoline mixture. Avoid getting dirt or water in the fuel tank.
- Occasionally you may hear a light “spark knock” or “pinging” (metallic rapping noise) while operating under heavy loads. This is no cause for concern.
- If spark knock or pinging occurs at a steady engine speed, under normal load, change brands of gasoline. If spark knock or pinging persists, see an authorized servicing dealer.

Fuel tank capacity:

1P65FE, 1P65FE-3 : 0.9L (0.24 US Gal, 0.20 Imp Gal)  
1P65FE-2, 1P65FE -4, 1P65FE-5 , V200 : 1.0L (0.26 US Gal , 0.22 Imp Gal)  
1P70F-3, 1P75F, V225-7: 1.4L (0.370 US Gal, 0.31 Imp Gal)

**WARNING**

- Do not use pressurized starting fluids.
- Vapors are flammable.

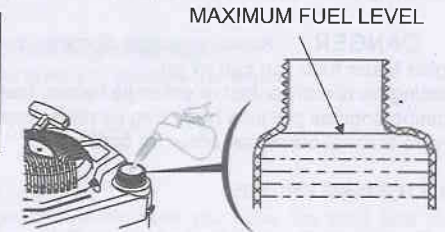

**DANGER:** Gasoline and its vapors are extremely flammable and explosive.

3.3 STARTING ENGINE

3.3.1 Control Lever

- **FOR STARTING A COLD ENGINE:** Move the Control Lever to the choke position.
- **FOR RESTARTING A WARM ENGINE:** Do not use the choke when the engine is warm. Move the control Level slightly past the idle position.
- **FLYWHEEL BRAKE MODELS:** Move the flywheel brake lever (located on equipment) to release the flywheel brake.

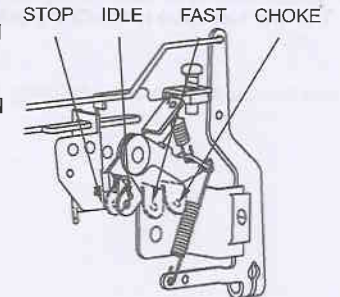

## CONTROLS

### 3.3.2 Start Engine

- Grasp rope handle. Pull slowly until resistance is felt, then pull rapidly to start engine and avoid kickback.
- If the choke was used to start the engine, move the throttle to the fast (or high) position as soon as the engine warms up enough to run smoothly without use of the choke.
- FLYWHEEL BRAKE MODELS: Continue to hold the flywheel brake lever (located on equipment). The engine will stop if you release the flywheel brake lever.
- If the engine is electric start version, use the key on the handle, switch for 3s.
- Position the control Level for the desired engine speed. For best engine performance, it is recommended the engine be operated with the throttle in the FAST (or high) position.



If using air pump carburetor, because there is no throttle rod, so press AIR PUMP 1 time to 3 times according to the direction of the arrow when cold start, then start it.

If using autochoke, start the engine without additional operations.

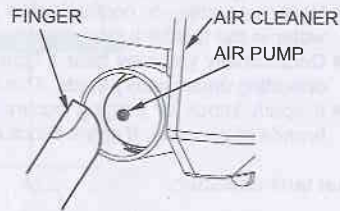

**CAUTION:** Carefully check if there is enough oil before starting.

For electric start, using short starting cycle is suggested (five seconds maximum), which extends the life of the starter. After every starting cycle, wait one minute.

**DANGER:** Rapid retraction of starter cord (kickback) will pull hand and arm toward engine faster than you can let go. Rotating parts can contact or entangle hands, feet, hair, clothing, or accessories. Running engines produce heat. Engine parts, especially muffler, become extremely hot. Severe thermal burns can occur on contact.

### 3.4 STOPPING ENGINE

- Engine with Flywheel Brake Models: Release the engine stop lever.  
or
- Engine with Throttle Control: Move the throttle control to the stop position.  
or
- Turn the fuel valve to the OFF position if you do not intend to restart the engine soon.

## MAINTENANCE

### 4. MAINTENANCE

#### 4.1 THE IMPORTANCE OF MAINTENANCE

Good maintenance is essential for safe, economical, and trouble-free operation. It will also help reduce air pollution.



#### WARNING

Improperly maintaining this engine, or failure to correct a problem before operation, can cause a malfunction in which you can be seriously hurt or killed. Always follow the inspection and maintenance recommendations and schedules in this owner's manual.

#### 4.2 MAINTENANCE SAFETY

Regular maintenance will improve the performance and extend the life of the engine.



#### WARNING

Failure to properly follow maintenance instructions and precautions can cause you to be seriously hurt or killed. Always follow the procedures and precautions in the owner's manual.

#### Safety Precautions

- Make sure the engine is off before you begin any maintenance or repairs. This will eliminate several potential hazards:
  - **Carbon monoxide poisoning from engine exhaust.**  
Be sure there is adequate ventilation whenever you operate the engine.
  - **Burns from hot parts.**  
Let the engine and exhaust system cool before touching.
  - **Injury from moving parts.**  
Do not run the engine unless instructed to do so.
- Read the instructions before you begin, and make sure you have the tools and skills required.
- To reduce the possibility of fire or explosion, be careful when working around gasoline. Use only a nonflammable solvent, not gasoline, to clean parts. Keep cigarettes, sparks and flames away from all fuel-related parts.

To ensure the best quality and reliability, use only new, genuine parts or their equivalents for repair and replacement.

## MAINTENANCE

### 4.3 MAINTENANCE SCHEDULE

REGULAR SERVICE PERIOD Performed at every indicated month or operating hour interval, whichever comes first.		Before Each use	First month or 5 Hrs.	Every 3 months or 25 Hrs.	Every 6 months or 50 Hrs.	Every year or 100 Hrs.
ITEM						
Engine oil	Check level	○				
	Change		○		○(1)	
Air cleaner	Check	○				
	Clean			○(2)		
	Replace					○☆
Spark plug	Check-Clean				○	
	Replace					○
Flywheel brake pad	Check				○	
Spark arrester (optional parts)	Clean				○	
Idle speed	Check-Adjust					○(3)
Valve clearance	Check-Adjust					○(3)
Combustion chamber	Clean	After every 100 Hrs. (3)				
Fuel line	Check	Every 2 years (Replace if necessary) (3)				

☆ Replace the paper element type only.

- (1) Change engine oil every 25 hours when used under heavy load or in high ambient temperatures.
- (2) Clean more often under dusty conditions or when airborne debris is present. Replace air cleaner parts, if very dirty.
- (3) These items should be serviced by your servicing dealer unless you have the proper tools and are mechanically proficient. Refer to manual for service procedures.

Failure to follow this maintenance schedule could result in nonwarrantable failures.

**CAUTION:** Used oil is a hazardous waste product. Dispose of used oil properly. Do not discard with household waste. We suggest you take used oil in a sealed container to your local recycling center or service station for reclamation.

#### 4.4 CHANGE ENGINE OIL

Drain the used oil while the engine is warm. Warm oil drains quickly and completely.

- 4.4.1 Place a suitable container below the engine to catch the used oil, and then remove the filler cap/dipstick, the drain bolt and sealing washer.
- 4.4.2 Allow the used oil to drain completely, and then reinstall the drain bolt and sealing washer, and tighten it securely.
- 4.4.3 With the engine in a level position, fill to the upper limit mark on the dipstick with the recommended oil.
- 4.4.4 Reinstall the oil filler cap/dipstick securely. Running the engine with a low oil level can cause engine damage.

## MAINTENANCE

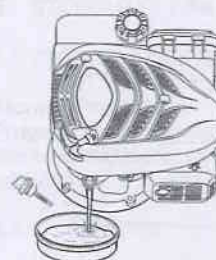

1P65FE, 1P65FE-3

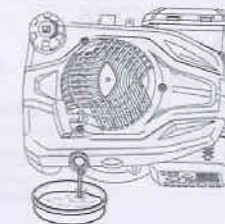

1P65FE-2, 1P65FE-4  
1P65FE-5, V200



1P70F-3, 1P75F, V225-7

### 4.5 REFUELING

With the engine stopped, remove the fuel tank cap and check the fuel level. Refill the tank if the fuel level is low.

Refuel in a well-ventilated area before starting the engine. If the engine has been running, allow it to cool. Refuel carefully to avoid spilling fuel. Do not fill above the fuel strainer/shoulder. After refueling, tighten the fuel tank cap securely.

Never refuel the engine inside a building where gasoline fumes may reach flames or sparks. Keep gasoline away from appliance pilot lights, barbecues, electric appliances, power tools, etc. Spilled fuel isn't only a fire hazard, it causes environmental damage. Wipe up spills immediately.

**CAUTION:** Fuel can damage paint and plastic. Be careful not to spill fuel when filling your fuel tank. Damage caused by spilled fuel is not covered under warranty.

### 4.6 AIR CLEANER

Remove the air cleaner cover and inspect the filter. Clean or replace dirty filter elements. Always replace damaged filter elements. If equipped with an oil-bath air cleaner, also check the oil level.

**CAUTION:** A dirty air filter will restrict air flow to the carburetor, reducing engine performance.

If you operate the engine in very dusty areas, clean the air filter more often than specified in the MAINTENANCE SCHEDULE.

#### 4.6.1 Inspection

- a) Press the latch tabs on the air cleaner cover or remove the cap nuts, and remove the cover. Check the filter to be sure it is clean and in good condition.
- b) Reinstall the filter and air cleaner cover.

#### 4.6.2 Cleaning

- a) Tap the filter several times on a hard surface to remove dirt, or blow compressed air (not exceeding 30 psi [ 207kPa, 2.1kg/cm<sup>2</sup> ] ) through the filter from the clean side that faces the engine. Never try to brush off dirt. Brushing will force dirt into the fibers.
- b) Tap the filter outer several times on a hard surface to remove dirt. Clean. If the filter outer is very dirty, replace the filter outer.
- c) Wipe dirt from the air cleaner body and cover using a moist rag. Be careful to prevent dirt from entering the air duct that leads to the carburetor.

## MAINTENANCE

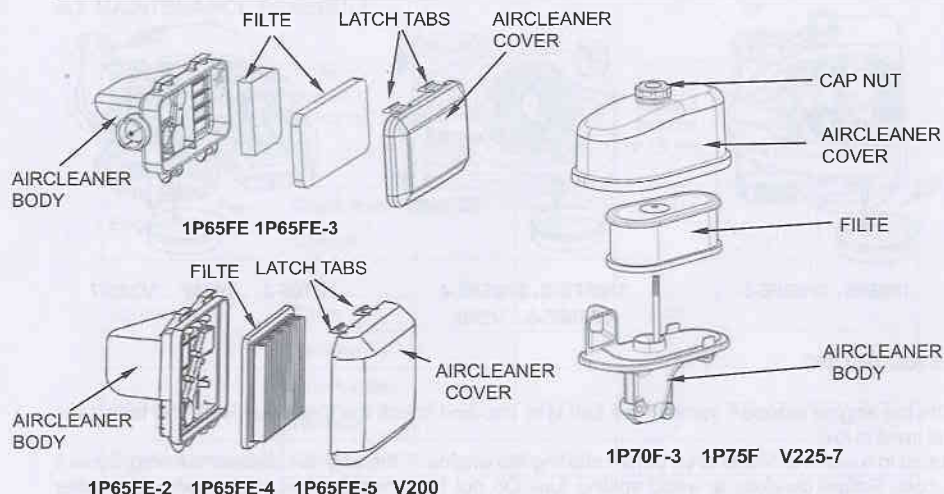

**CAUTION:** Operating the engine without an air filter, or with a damaged air filter, will allow dirt to enter the engine, causing rapid engine wear. This type of damage is not covered by the Distributor's Limited Warranty.

### 4.7 SPARK PLUG SERVICE

Recommended spark plugs: F7RTC or other equivalents.

**CAUTION:** An incorrect spark plug can cause engine damage.

- 4.7.1 Disconnect the spark plug cap, and remove any dirt from around the spark plug area.
- 4.7.2 Remove the spark plug with a spark plug wrench.
- 4.7.3 Inspect the spark plug. Replace it if the electrodes are worn, or if the insulator is cracked or chipped.
- 4.7.4 If the insulator is cracked or chipped.
- 4.7.5 Measure the spark plug electrode gap with a suitable gauge.  
The gap should be 0.028 – 0.031 in (0.70 - 0.80 mm). Correct the gap, if necessary, by carefully bending the side electrode.
- 4.7.6 Install the spark plug carefully, by hand, to avoid cross-threading.
- 4.7.7 After the spark plug seats, tighten with a spark plug wrench to compress the water.  
If reinstalling the used spark plug, tighten 1/8 - 1/4 turn after the spark plug seats.  
If installing a new spark plug, tighten 1/2 turn after the spark plug seats.



**CAUTION:** A loose spark plug can overheat and damage the engine. Over tightening the spark plug can damage the threads in the cylinder head.

- 4.7.8 Attach the spark plug cap.

## STORAGE/TRANSPORTING

### 5. STORAGE/ TRANSPORTING

#### 5.1 STORING YOUR ENGINE

##### Storage Preparation

Proper storage preparation is essential for keeping your engine trouble free and looking good. The following steps will help to keep rust and corrosion from impairing your engine's function and appearance, and will make the engine easier to start after storage.

##### 5.1.1 Cleaning

If the engine has been running, allow it to cool for at least half an hour before cleaning. Clean all exterior surfaces, touch up any damaged paint, and coat other areas that may rust with a light film of oil.

**CAUTION:** Using a garden hose or pressure washing equipment can force water into the air cleaner or muffler opening. Water in the air cleaner will soak the air filter, and water that passes through the air filter or muffler can enter the cylinder, causing damage.

Water contacting a hot engine can cause damage. If the engine has been running, allow it to cool for at least half an hour before washing.

##### 5.1.2 Fuel

Gasoline will oxidize and deteriorate in storage. Old gasoline will cause hard starting, and it leaves gum deposits that clog the fuel system. If the gasoline in your engine deteriorates during storage, you may need to have the carburetor and other fuel system components serviced or replaced.

The length of time that gasoline can be left in your fuel tank and carburetor without causing functional problems will vary with such factors as gasoline blend, your storage temperatures, and whether the fuel tank is partially or completely filled. The air in a partially filled fuel tank promotes fuel deterioration. Very warm storage/temperatures accelerate fuel deterioration. Fuel deterioration problems may occur within a few months, or even less if the gasoline was not fresh when you filled the fuel tank.

The Distributor's Limited Warranty does not cover fuel system damage or engine performance problems resulting from neglected storage preparation.

You can extend fuel storage life by adding a fuel stabilizer that is formulated for that purpose, or you can avoid fuel deterioration problems by draining the fuel tank and carburetor.

##### 5.1.3 Adding A Fuel Stabilizer To Extend Fuel Storage Life

When adding a fuel stabilizer, fill the fuel tank with fresh gasoline. If only partially filled, air in the tank will promote fuel deterioration during storage. If you keep a container of gasoline for refueling, be sure that it contains only fresh gasoline.

- a) Add fuel stabilizer following the manufacturer's instructions.
- b) After adding a fuel stabilizer, run the engine outdoors for 10 minutes to be sure that treated gasoline has replaced the untreated gasoline in the carburetor.
- c) Stop the engine.



## STORAGE/TRANSPORTING

### 5.1.4 Draining The Fuel Tank And Carburetor

- Place an approved gasoline container below the carburetor, and use a funnel to avoid spilling fuel.
- Remove the carburetor drain bolt and sealing washer, and then move the fuel valve lever to the ON position.
- After all the fuel has drain into the container, reinstall the drain bolt and sealing washer. Tighten them securely.

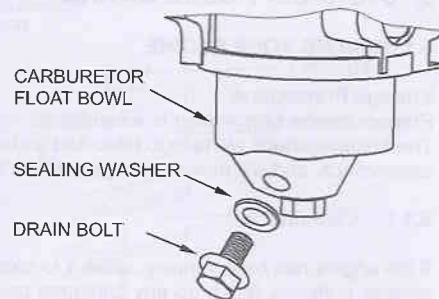

### 5.2 STORAGE PRECAUTIONS

- Change the engine oil.
- Remove the spark plugs.
- Pour a tablespoon (5-10 cc) of clean engine oil into the cylinder.
- Pull the starter rope several times to distribute the oil in the cylinder.
- Reinstall the spark plugs.
- Pull the starter rope slowly until resistance is felt. This will close the valves so moisture cannot enter the engine cylinder. Return the starter rope gently.

If your engine will be stored with gasoline in the fuel tank and carburetor, it is important to reduce the hazard of gasoline vapor ignition. Select a well-ventilated storage area away from any appliance that operates with a flame, such as a furnace, water heater, or clothes dryer. Also avoid any area with a spark-producing electric motor, or where power tools are operated. If possible, avoid storage areas with high humidity, because that promotes rust and corrosion. Unless all fuel has been drained from the fuel tank, leave the fuel valve lever in the OFF position to reduce the possibility of fuel leakage.

Position the equipment so the engine is level. Tilting can cause fuel or oil leakage.

- With the engine and exhaust system cool, cover the engine to keep out dust. A hot engine and exhaust system can ignite or melt some materials. Do not use sheet plastic as a dust cover. A nonporous cover will trap moisture around the engine, promoting rust and corrosion.

**⚠ WARNING** The length of time that gasoline can be left in your fuel tank and carburetor without causing functional problems will vary with such factors as gasoline blend, your storage temperatures, and whether the fuel tank is partially or completely filled. The air in a partially filled fuel tank promotes fuel deterioration. Very warm storage temperatures accelerate fuel deterioration. Gasoline will oxidize and deteriorate in storage. Deteriorated gasoline will cause hard starting, and it leaves gum deposits that clog the fuel system. As a result, if the engine is not used for more than one month, the fuel oil shall be drained thoroughly to prevent from deterioration of the fuel in fuel system and carburetor.

The failures of fuel system or engine performance arising from improper storage are beyond the scope of the warranty.

## STORAGE/TRANSPORTING

### 5.3 REMOVAL FROM STORAGE

Check your engine as described in the chapter OPERATION.

If the fuel was drained during storage preparation, fill the tank with fresh gasoline. If you keep a container of gasoline for refueling, be sure that it contains only fresh gasoline. Gasoline oxidizes and deteriorates over time, causing hard starting.

If the cylinders were coated with oil during storage preparation, the engine may smoke briefly at startup. This is normal.

### 5.4 TRANSPORTING

If the engine has been running, allow it to cool for at least 15 minutes before loading the engine-powered equipment on the transport vehicle. A hot engine and exhaust system can burn you and can ignite some materials.

Keep the engine level when transporting to reduce the possibility of fuel leakage. Move the fuel valve lever to the OFF position.

## TROUBLESHOOTING

### 6. TROUBLESHOOTING

Engine Will Not Start	Possible Cause	Correction
1. Check control positions	Choke OPEN.	Move lever to CLOSE unless engine is warm.
	Engine switch OFF.	Turn engine switch to ON.
2. Check fuel.	Out of fuel.	Refuel
	Bad fuel; engine stored without treating or draining gasoline, or refueled with bad gasoline.	Drain fuel tank and carburetor. Refuel with fresh gasoline.
3. Remove and inspect spark plugs.	Spark plugs faulty, fouled, or improperly gapped.	Gap, or replace spark plugs.
	Spark plugs wet with fuel (flooded engine).	Dry and reinstall spark plugs. Start engine with control lever in FAST position.
4. Take engine to an authorized servicing dealer, or refer to manual.	Fuel filter clogged, carburetor malfunction, ignition malfunction, valve stuck, etc.	Replace or repair faulty components as necessary.
Engine Lacks Power	Possible Cause	Correction
1. Check air filter	Filter element(s) clogged.	Clean or replace filter element(s).
	Out of fuel.	Refuel
2. Check fuel.	Bad fuel; engine stored without treating or draining gasoline, or refueled with bad gasoline.	Drain fuel tank and carburetor. Refuel with fresh gasoline.
	Fuel filter clogged, carburetor malfunction, ignition malfunction, valve stuck, etc.	Replace or repair faulty components as necessary.
3. Take engine to an authorized servicing dealer, or refer to manual.		
Engine Operates Erratically	Possible Cause	Correction
1. Check spark plug	Spark plug is defective.	Install new, correctly gapped plug.
	Spark plug gap is incorrect.	Set gap between electrodes at 0.7 to 0.8 mm.
2. Check air cleaner	Air cleaner element is dirty.	Clean air cleaner element.

## TECHNICAL & CONSUMER INFORMATION

### 7. TECHNICAL & CONSUMER INFORMATION

#### Serial Number Location

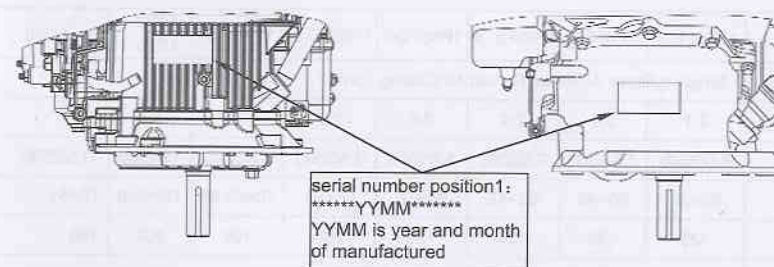

Record the engine serial number in the space below. You will need this serial number when ordering parts, and when making technical or warranty inquiries.

**Engine serial number:** \_\_\_\_\_

#### Maintenance

Follow the maintenance schedule. Remember that this schedule is based on the assumption that your machine will be used for its designed purpose. Sustained high-load or high-temperature operation, or use in unusually wet or dusty conditions, will require more frequent service.

#### Engine Tune-up

ITEM	SPECIFICATION
Spark Plug Gap	0.028-0.031 in (0.70-0.80 mm)
Valve Clearance	IN: 0.10~0.15mm (cold) EX: 0.10~0.15 mm (cold) (1P65FE/1P65FE-3)EX: 0.15~0.2mm (cold)

#### Quick Reference Information

Engine Oil	Type	SAE 10W-30, API SE or SF, for general use
	Capacity	0.5L (0.132 US Gal, 0.110 Imp Gal)
Spark Plug	Type	F7RTC or other equivalents.
	Gap	0.028-0.031 in (0.70-0.80 mm)
Carburetor	Idle speed	1800 ± 150 rpm
Maintenance	Each use	Check engine oil. Check air filter.
	First 5 hours	Change engine oil.
	Subsequent	Refer to the maintenance

## SPECIFICATIONS

### 8. SPECIFICATIONS

#### ENGINE SPECIFICATIONS

Model	1P65FE-3	1P65FE	1P65FE- 4	1P65FE-5	1P65FE-2	1P70F-3	1P75F V225-7	V200
Type	Single cylinder, 4-Stroke, Forced Air Cooling, OHV							
Net power(kW/3600rpm)	2.1	2.4	2.4	2.6	2.9	4.0	4.5	3.7
Net torque (N·m/rpm)	6.5/2500	7.5/2500	7.5/2500	8.2/2500	9.5/2500	12/2500	14/2500	11.5/2500
Bore x Stroke(mm)	65×37	65×42	65×42	65×46	65×50	70×50.84	75×50.8	70×51
Displacement(cc)	123	139	139	153	166	196	224	196
Lubricating mode	Splash							
Starting Mode	Recoil start				Recoil start/Electric start			
Rotation	Anti-clockwise(from P.T.O. side)							
Igniting Mode	Transistorized magneto Ignition							
Dimension(L×W×H)(mm) ★	328×318×245		RS: 385×340×250			384×341×258		385×340×250
Net weight (kg) ★	8.5	8.5	8.8	8.9	9	2.8	12.4	9.3

The power rating of the engine indicated in this document is the net power output tested on a production engine for the engine model and measured in accordance with SAE J1349 at 3,600 rpm (Net Power) and at 2,500 rpm (Net Torque) . Mass production engines may vary from this value.

Actual power output for the engine installed in the final machine will vary depending on numerous factors, including the operating speed of the engine in application, environmental conditions, maintenance, and other variables.

★ Approximate value. Actual products may vary due to different configurations.